

this is proformance

**FLEX**

# Making everything shine

Polishing and Automotive Products

**3**

YEARS

FLEX WARRANTY

**3-year warranty\***

Simply register and get started.  
<https://warranty.flex-tools.com>

\* Applies to battery packs and chargers too.

# So that it's all as good

# as new

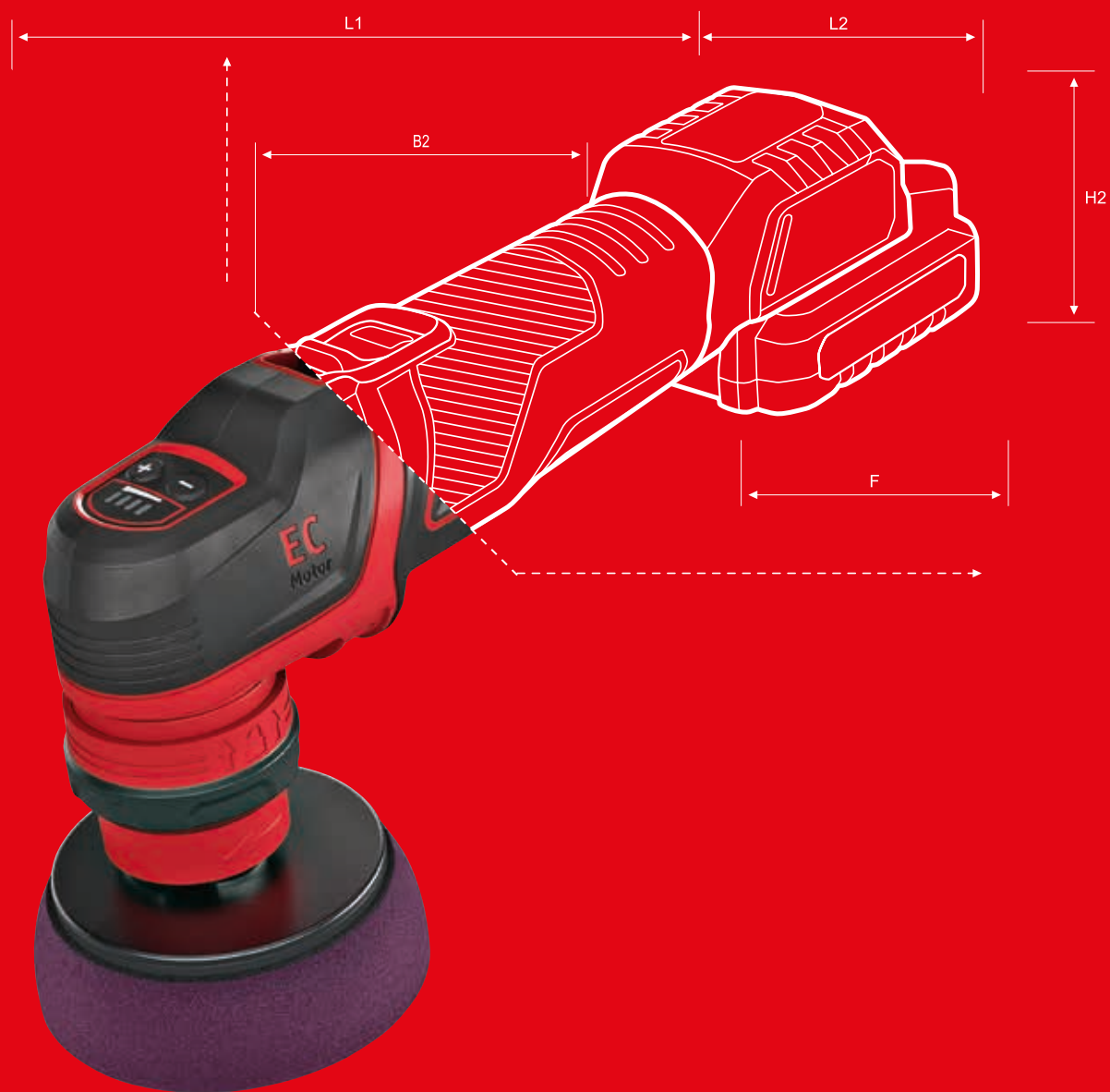

Three things are needed for the perfect surface finish: skill, the right feel, and FLEX, of course. Whether you are a professional working in a paint shop, an automotive all-rounder or a detailer - FLEX allows everyone to shine with the optimum system of polisher, pad and polish. The right combination is particularly important, because with the correct components to suit your experience, the material and the condition of the paintwork, you are certain to achieve brilliant results.

# System with in-built safety

The right combination for perfect surfaces



## Polisher

There are good reasons why FLEX polishers are the first choice of the professionals. FLEX has been defining the high technological standard for premium polishers for more than 90 years and thus has unique know-how which ensures our tools are noticeably better.



## Pad

The optimum result is achieved only with the correct choice of polishing medium. The user must be familiar with the different effects produced by foams or fibre-based products such as fleece, wool and microfibre pads if they are to achieve the desired abrasive effect. The FLEX pads with colour-coded system provide clear guidance here.



## Polish

The FLEX system is rounded off with perfectly coordinated abrasive, finishing and sealing polishes. They are the perfect match for our system and are silicone-free, of course.

**Achieve  
your goal  
with the  
correct  
drive**



# Experience and task determine the technology needed

FLEX provides the whole range of drive technologies for polishers and thus solutions for all types of user, be they a professional or a beginner with little experience. As a matter of principle: rotary polishers achieve a high removal rate and thus belong in experienced hands only because the workpiece usually requires subsequent finishing with a random orbital polisher.

## Drive

## Properties

### Rotary

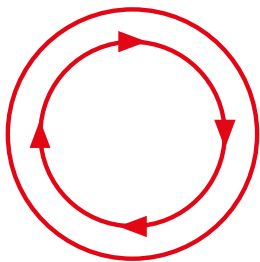

- Highest removal rate
- Rotary polishers require experience
- Quickest way to remove scratches
- Hologram formation possible

#### Abrasiveness



#### Speed <sup>1</sup>



#### Holograms <sup>2</sup>



#### Hologram removal



### Random orbital, with positive-action drive

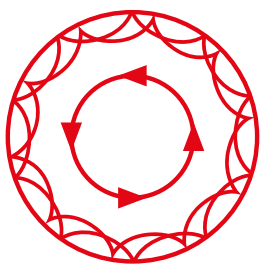

- Good removal performance
- No hologram formation
- Suitable for removing scratches and for finishing
- Wide range of applications

#### Abrasiveness



#### Speed <sup>1</sup>



#### Holograms <sup>2</sup>



#### Hologram removal



### Random orbital, free-running

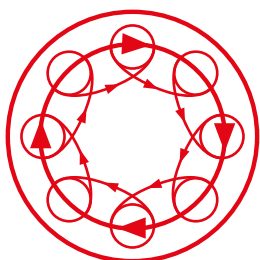

- Suitable for all types of user
- Easy to handle
- No hologram formation
- Poor removal performance
- Ideal for finishing

#### Abrasiveness



#### Speed <sup>1</sup>



#### Holograms <sup>2</sup>



#### Hologram removal



1 Time required to remove damage  
2) Risk of hologram formation

Rotary polisher

# Great performance, great removal

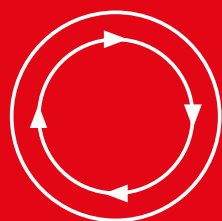

# PE 14-2 150

The high-end polisher for professional car restoration.  
Perfect speed range plus high torque.

## Technical features

- + Microprocessor electronics: continuously adjustable speed selection, tachometer-controlled constant speed, overload protection, restart protection and temperature monitoring
- + Powerful 1,400-watt motor with powerful fan for optimum cooling
- + Accelerator trigger switch for a slow and gentle start (starting speed at setting 1 (380 rpm)) and lock for continuous operation
- + Optimised airflow for the best possible cooling effect of the motor and gearbox. No exhaust air to annoy the user
- + Novel combination of planetary and angle gear reduces noise to a minimum
- + Flat gear head reduces the distance from the surface. This allows the tool to be operated correctly in any position
- + Handle cover: ergonomically shaped with Soft-Grip. The tool can be guided with precision and always provides a pleasant and safe grip
- + Spindle lock: is ideally positioned to avoid operating errors and not to influence the grip area
- + With rubber-coated storage surface for safe storage
- + 4-metre PUR H05-BQF cable: wear resistant, flexible with high abrasion and notch resistance

## PE 14-2 150

### Standard equipment

- 1 handle
- 

Order No.

373680

### Technical data

Max. polishing pad Ø	200 mm
Max. backing pad Ø	150 mm
No-load speed	380-2100/min
Power consumption	1400 W
Tool fixture	M 14
Weight	2.3 kg

## High-end basic polisher for:

- + Car restoration
- + Bodywork
- + Paint shop
- + Car repair shop
- + Smart repair
- + Aviation
- + Maritime
- + Furniture
- + Acrylic glass

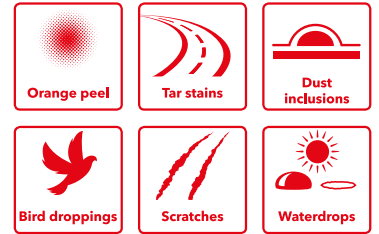

## PE 14-2 150 P-Set

### Standard equipment

- 1 handle
- 1 hook and loop backing pad, cushioned Ø 150 mm
- 1 polishing wool pad TW-PT 160
- 1 microfibre cloth MW-P
- 1 case insert
- 1 polishing sponge PS-O 160
- 1 polishing sponge PS-V 160
- 1 polish P03/06-LDX 250 ml
- 1 polish P05/05-LDX 250 ml
- 1 carrying case L-BOXX® 238



Order No.

376175

# PE 14-1 180

The specialist for large areas and heat-sensitive materials or when large polishing pads are required.

## Technical features

As PE 14-2 150

- + Accelerator trigger switch for a slow and gentle start (starting speed at setting 1 (250 rpm)) and lock for continuous operation
- + Specially designed for polishing large horizontal and vertical surfaces. For automotive, maritime, aviation applications
- + Polishes with extremely low speed and high torque, e. g. for heat-sensitive surfaces

## High-end polisher for:

- + Maritime
- + Aviation
- + Car restoration
- + Furniture
- + Acrylic glass



## Technical data

Max. polishing pad Ø	250 mm
Max. backing pad Ø	180 mm
No-load speed	250-1380/min
Power consumption	1400 W
Tool fixture	M 14
Weight	2.3 kg

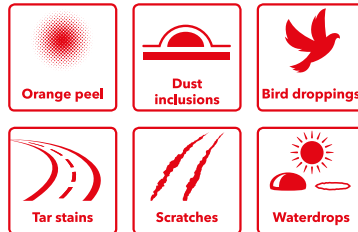

## PE 14-1 180

### Standard equipment

- 1 handle

Order No.

395749

# PE 8-4 80

The handy polisher for small areas. Ideal as an ancillary tool.

## Technical features

- + VR Electronics: with tachometer-controlled constant speed, soft start, overload protection and speed preselection
- + Lightweight and handy for use on smaller areas, difficult to reach places
- + Spindle lock

## Ancillary polisher for

- + Car restoration
- + Bodywork
- + Smart repair



## Technical data

Max. polishing pad Ø	80 mm
Max. backing pad Ø	75 mm
No-load speed	1300-3900/min
Power consumption	800 W
Tool fixture	M 14
Weight	1.8 kg

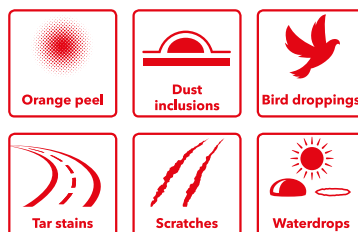

## PE 8-4 80

### Standard equipment

- 1 side handle

Order No.

405817



# PE 14-3 125

The all-rounder for small to medium-sized polishing discs.

## Technical features

- ⊕ VR microprocessor electronics: with tachometer-controlled constant speed, soft start, accelerator trigger switch, restart protection after power failure, overload protection, temperature monitoring and speed preselection
- ⊕ Accelerator trigger switch for a slow and sensitive start
- ⊕ Thanks to the wide speed range, ideally suited to work perfectly with polishing pads from Ø 80 to max. Ø 160 mm
- ⊕ Recommended polishing pad Ø 140 mm
- ⊕ Ergonomic design
- ⊕ Slim handle and ergonomically shaped handle cover for optimum handling and fatigue-free polishing
- ⊕ 4-metre PUR H05-BQF cable: wear resistant, flexible with high abrasion and notch resistance
- ⊕ Spindle lock

## Ancillary polisher for

- ⊕ Workshops
- ⊕ Bodywork
- ⊕ Paint shop
- ⊕ Smart repair

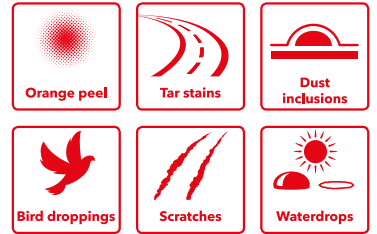

## Technical data

Max. polishing pad Ø	160 mm
Max. backing pad Ø	125 mm
No-load speed	1100-3700/min
Power consumption	1400 W
Tool fixture	M 14
Weight	2.2 kg

## PE 14-3 125

### Standard equipment

- 1 side handle

Order No.

406813

## PE 14-3 125 P-Set

### Standard equipment

- 1 side handle
- 1 hook and loop backing pad, Ø 125
- 1 microfibre cloth MW-PC
- 1 polishing sponge PS-O 160
- 1 polishing sponge PS-V 160
- 1 polish P03/06-LDX 250 ml
- 1 polish P05/05-LDX 250 ml



Order No.

407569

Random orbital polisher with positive-action drive

# Full control during every revolution



# XCE 10-8 125

Rotary and random orbital motions combined in one polisher. For effective and efficient surface finishing.

## Technical features

- + VR microprocessor electronics: with tachometer-controlled constant speed, soft start, accelerator trigger switch, restart protection after power failure, overload protection, temperature monitoring and speed preselection
- + 8 mm polishing stroke, positive-action drive provides high abrasive power without creating any holograms
- + Cushioned special hook and loop backing pad for polishing
- + Very smooth running thanks to balancing mass
- + Basic unit for hologram-free working on the most common surface problems through to finishing
- + Flat gear head reduces the distance from the surface. This allows the tool to be operated correctly in any position
- + Handle cover: ergonomically shaped with Soft-Grip. The tool can be guided with precision and always provides a pleasant and safe grip
- + Optimised airflow for the best possible cooling effect of the motor and gearbox. No exhaust air to annoy the user
- + Low heat generation on the surface makes it ideal for temperature-sensitive paints

## Random orbital polisher for:

- + Car restoration
- + Car dealers
- + Paint shop
- + Car repair shop
- + Smart repair
- + Maritime



## XCE 10-8 125

### Standard equipment

- 1 special hook & loop backing pad, 125 Ø

Order No.

418072

### Technical data

Max. polishing pad Ø	160 mm
Max. backing pad Ø	150 mm
No-load speed	140-430/min
Stroke rate at no-load	2900-8600/min
Stroke	8 mm
Power consumption	1010 W
Weight	2.6 kg

## XCE 10-8 125 P-Set

### Standard equipment

- 1 special hook and loop backing pad Ø 125 mm
- 1 polishing sponge PS-O 140
- 1 polishing sponge PSX-G 140
- 1 polish P03/06-LDX 250 ml
- 1 polish P05/05-LDX 250 ml
- 1 microfibre cloth MW-PC
- 1 carrying case L-BOXX® 238
- 1 case insert



Order No.

447269

Free-running random orbital polisher

# Always in good hands



# XFE 7-15 150

Ideal for beginners or when working on 2-stage processes. As a supplementary tool to the rotary polisher, it provides fast hologram removal and a perfect finish.

## Technical features

- + VR microprocessor electronics: with tachometer-controlled constant speed, soft start, accelerator trigger switch, restart protection after power failure, overload protection, temperature monitoring and speed preselection
- + Free-running drive for hologram-free finishing
- + 15 mm polishing stroke for high efficiency
- + Accelerator trigger switch for a slow and sensitive start and locking for continuous running
- + Cushioned special hook and loop backing pad for polishing
- + Very smooth running thanks to balancing mass
- + Optimised airflow for the best possible cooling effect of the motor and gearbox.
- + Flat gear head reduces the distance from the surface. This allows the tool to be operated correctly in any position
- + Handle cover: ergonomically shaped with Soft-Grip.
- + Low heat generation on the surface makes it ideal for temperature-sensitive paints

## XFE 7-15 150

### Standard equipment

- 1 special hook and loop backing pad, Ø 125
- 1 special hook and loop backing pad, Ø 150

Order No.

418080

### Technical data

Max. polishing pad Ø	160 mm
Max. backing pad Ø	150 mm
No-load speed	1500-4500/min
Stroke rate at no-load	3000-9000/min
Stroke	15 mm
Power consumption	710 W
Weight	2.4 kg

## Random orbital polisher

for:

- + Car restoration
- + Car dealers
- + Paint shop
- + Car repair shop
- + Smart repair
- + Maritime



Holograms



Matting



Car wash traces



Paint care sealant



Slight scratches

## XFE 7-15 150 P-Set

### Standard equipment

- 1 special hook and loop backing pad, Ø 125
- 1 special hook and loop backing pad, Ø 150
- 1 polishing sponge PS-O 160
- 1 polishing sponge PS-R 160
- 1 microfibre cloth MW-C
- 1 polish P03/06-LDX 250 ml
- 1 sealant W02/04 250 ml
- 1 carrying case L-BOXX® 238
- 1 case insert



Order No.

447110

**Note:** If the original FLEX accessories are not used with the XFE/XCE models, this can lead to increased vibrations, a poorer end result or increased wear, or even cause equipment damage!

# XFE 7-12 80

The small, compact tool is the ideal complement to larger polishers. Perfect for spot repairs. It can be used for a large number of applications when working with difficult shapes.

## Technical features

- + VR Electronics: with tachometer-controlled constant speed, soft start, overload protection, temperature monitoring and speed preselection
- + Free-running drive for hologram-free finishing
- + Handle cover: ergonomically shaped with Soft-Grip. The tool can be guided with precision and always provides a pleasant and safe grip
- + 12 mm polishing stroke for high efficiency
- + Lightweight and handy for use on smaller areas, difficult to reach places
- + Low heat generation on the surface makes it ideal for temperature-sensitive paints
- + Perfect for spot repairs and difficult shapes. Ideal complement to larger polishers

## Supplementary polisher for:

- + Car restoration
- + Car repair shop
- + Smart repair
- + Maritime
- + Acrylic glass



## XFE 7-12 80

### Standard equipment

- 1 special hook and loop backing pad Ø 75

Order No.

447129

### Technical data

Max. polishing pad Ø	80 mm
Max. backing pad Ø	75 mm
No-load speed	1800-5500/min
Stroke rate at no-load	3600-10800/min
Stroke	12 mm
Power consumption	700 W
Weight	2.1 kg

## XFE 7-12 80 P-Set

### Standard equipment

- 1 special hook and loop backing pad Ø 75
- 1 polishing sponge PSX-G 80
- 1 polishing sponge PS-O 80
- 1 polishing sponge PS-R 80
- 1 microfibre cloth MW-PC
- 1 polish P05/05-LDX 250 ml
- 1 sealant W02/04 250 ml
- 1 carrying case L-BOXX® 136
- 1 case insert

Order No.

447137



**Note:** If the original FLEX accessories are not used with the XFE/XCE models, this can lead to increased vibrations, a poorer end result or increased wear, or even cause equipment damage!



# Enjoy the freedom

**FLEX is and will remain the benchmark for professional quality in the field of polishing - even with 18 V battery power. High end surface finishing then becomes as independent and flexible as never before. A matter of course: There are no compromises in terms of performance and security in the system. True performance.**





# Cordless polisher - The full range

- ⑦ Random orbital or rotational drive technology
- ⑦ For all users from professional polishers to beginners
- ⑦ For all painted surfaces in automotive, caravanning, aviation, and maritime applications
- ⑦ Two exchangeable batteries for work without breaks
- ⑦ For perfect results

## Perfect balance

Maximum freedom of movement and ergonomics for the user. The optimum location of the battery not only perfects the spread of weight, but also promotes the polisher's high-response manoeuvrability without disruptive elements and any possible contact with the painted workpiece. Never before has the polisher been so responsive!



# Powerful battery technology



## Thermo-Tech™ technology

Integrated cooling - The innovative thermal management allows you to work at full power for much longer.



## KEEP CONTROL technology

Intelligent battery management system - constant data exchange between battery pack, tool and quick charger.



## POWER BATTERY

High-performance battery cells - The FLEX high-performance cells use the full battery capacity and thus allow longer battery runtimes!



## EC technology means tool requires no maintenance whatsoever

- ⑦ Up to 65% longer runtime
- ⑦ Up to 10x longer service life
- ⑦ Up to 30% more power

Cordless rotary polisher

# Polishing with Proformance

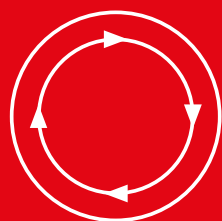

# PE 150 18.0-EC

Concentrated power with high speed for high removal rate

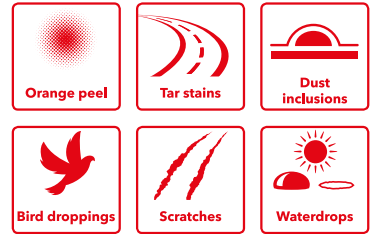

## Technical features

- + Intelligent Electronic Management System
- + Centrally positioned speed wheel can be operated from both sides
- + Spindle lock
- + Ergonomic handle with SoftGrip
- + Durable and powerful EC motor
- + Accelerator trigger switch with lock
- + Ergonomic handle cover with Soft-Grip
- + M14 tool holder

## Cordless rotary polisher for:

- + Vehicle cleaners
- + Car repair shops
- + Smart repairs
- + Aviation
- + Maritime
- + Acrylic glass industry



## Technical data

Max. polishing pad Ø	160 mm
Max. backing pad Ø	150 mm
Tool holder	M14
No-load speed	150-1450/min
Battery voltage	18 V
Battery capacity	2.5 / 5.0 Ah
Average battery runtime 2.5 Ah	up to 15 min
Average battery runtime 5.0 Ah	up to 35 min
Weight excluding battery	1.9 kg
Weight with 5.0 Ah battery	2.7 kg

## PE 150 18.0-EC C

### Supplied in a box

#### Standard equipment

- 1 hook and loop backing pad, Ø 150 mm
- 1 handle

Order No.

493856

## PE 150 18.0-EC

### Standard equipment

- 1 hook and loop backing pad, Ø 150 mm
- 1 handle
- 1 carrying case L-BOXX® 238
- 1 case insert



Order No.

459062

## PE 150 18.0-EC/5.0 Set

### Standard equipment

- 1 hook and loop backing pad, Ø 150 mm
- 1 handle
- 2 rechargeable batteries 5.0 Ah AP 18.0/5.0
- 1 charger CA 10.8/18.0
- 1 carrying case L-BOXX® 238
- 1 case insert



Order No.

447153

## PE 150 18.0-EC/5.0 P-Set

### Standard equipment

- 1 polishing sponge PS-0 160
- 1 polishing sponge PS-V 160
- 1 polishing wool pad TW-PT 160
- 1 polish P03/06-LDX 250 ml
- 1 polish P05/05-LDX 250 ml
- 1 microfibre cloth MW-P
- 1 hook and loop backing pad, Ø 150 mm
- 1 handle
- 2 rechargeable batteries 5.0 Ah AP 18.0/5.0
- 1 charger CA 10.8/18.0
- 1 carrying case L-BOXX® 238
- 1 case insert



Order No.

461229

Free-running cordless eccentric polisher

# Carefully forwards



# XFE 15 150 18.0-EC

Random orbital polishers remove material gently for reliable results. That makes them ideal for beginners.



Holograms



Matting



Car wash traces



Paint care sealant



Slight scratches

## Technical features

- ⊕ Electronic management system (EMS) protects the tool, extends its service life and increases efficiency
- ⊕ Brushless motor with greater efficiency and a longer service life
- ⊕ LED battery capacity capacity indicator
- ⊕ Free-running drive for hologram-free finishing
- ⊕ 15 mm polishing stroke for high efficiency
- ⊕ Accelerator trigger switch for a slow and sensitive start
- ⊕ Cushioned special hook and loop backing pad for polishing
- ⊕ Very smooth running thanks to to balancing mass
- ⊕ Flat gear head reduces the distance from the surface.
- ⊕ Handle cover: ergonomically shaped with SoftGrip.
- ⊕ Low heat generation on the surface makes it ideal for temperature-sensitive paints

## Cordless eccentric polisher for:

- ⊕ Vehicle cleaners
- ⊕ Car repair shops
- ⊕ Smart repairs
- ⊕ Aviation
- ⊕ Car dealers
- ⊕ Maritime
- ⊕ Acrylic glass industry



## Technical data

Max. polishing pad Ø	160 mm
Max. backing pad Ø	150 mm
Stroke	15 mm
No-load speed	2300-3800/min
Stroke rate at no-load	4600-7600/min
Battery voltage	18 V
Battery capacity	2.5 / 5.0 Ah
Average battery runtime 2.5 Ah	up to 20 min
Average battery runtime 5.0 Ah	up to 45 min
Weight excluding battery	2.1 kg
Weight with 5.0 Ah battery	2.8 kg

## XFE 15 150 18.0-EC C

### Supplied in a box

#### Standard equipment

- Special hook and loop backing pad Ø 125 mm
- 1 backing pad Ø 150 mm

Order No.

493864

## XFE 15 150 18.0-EC

### Standard equipment

- 1 special hook and loop backing pad Ø 125 mm
- 1 special hook and loop backing pad Ø 150 mm
- 1 carrying case L-BOXX® 238
- 1 case insert



Order No.

459089

## XFE 15 150 18.0-EC/5.0 Set

### Standard equipment

- 1 special hook and loop backing pad Ø 125 mm
- 1 special hook and loop backing pad Ø 150 mm
- 2 rechargeable batteries 5.0 Ah AP 18.0/5.0
- 1 charger CA 10.8/18.0
- 1 carrying case L-BOXX® 238
- 1 case insert



Order No.

418099

## XFE 15 150 18.0-EC/5.0 P-Set

### Standard equipment

- Special hook and loop backing pad Ø 125 mm
- 1 backing pad Ø 150 mm
- 1 polish P03/06-LDX 250 ml
- 1 sealant W02/04 250 ml
- 1 microfibre cloth MW-PC
- 1 polishing sponge PS-0 160
- 1 polishing sponge PS-R 160
- 2 rechargeable batteries 5.0 Ah AP 18.0/5.0
- 1 charger CA 10.8/18.0
- 1 carrying case L-BOXX® 238
- 1 case insert



Order No.

461237

Cordless random orbital / rotary polishers

# Master of the quick change

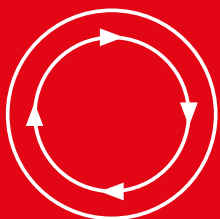

10 sec.

Can be converted in just  
10 seconds - no tools,  
no stress.



# PXE 80 10.8-EC

The all-rounders for spot repairs and vehicle preparation is up to any task, from blossom sanding to hologram-free finishing.

## Technical features

- + Brushless motor
- + Electronic Management System (EMS)
- + Innovative quick-change system for exchanging the rotary and eccentric drive types without using tools
- + For rotary and random orbital free-running working with 3 and 12 mm stroke
- + Flexible and easy as never before from blossom sanding to hologram-free finishing with one unit
- + Accelerator trigger switch for a slow and sensitive start and locking for continuous running
- + With constant speed control and 4 speed levels, display easily recognisable by LEDs
- + Very smooth running thanks to vibration optimisation
- + Cushioned special hook and loop backing pad
- + With impact protection ring to protect surfaces
- + The ideal complementary tool for every vehicle refurbisher, painter and the spot repair trade.

## PXE 80 10.8-EC

### Supplied in a box

Order No.  
469068

## PXE 80 10.8-EC/2.5 Set

### Standard equipment

- 1 adapter, rotary DT-P
- 1 random-orbital adapter, 3 mm stroke DT-XF3
- 1 random-orbital adapter, 12 mm stroke DT-XF12
- 1 adhesive pad 30 Ø BP-M/SR D30 PXE
- 1 hook & loop backing pad 30 Ø BP-M D30 PXE
- 1 hook & loop backing pad 75 Ø BP-M D75 PXE
- 2 rechargeable batteries 2.5 Ah AP 10.8/2.5
- 1 charger CA 10.8/18.0
- 1 carrying case L-BOXX® 136
- 1 case insert



Order No.  
418102

## Cordless eccentric polisher

### for:

- + Vehicle cleaners
- + Smart repairs
- + Paint shop
- + Car body shops
- + Car repair shops



## Technical data

Max. polishing pad Ø	80 mm
Max. backing pad Ø	75 mm
Stroke	3 + 12 mm
No-load speed	400-2000/-3000/-4000/-5800/min
Stroke rate at no-load	800-4000/-6000/-8000/-11600/min
Battery voltage	10.8 V
Battery capacity	2.5 / 4.0 / 6.0 Ah
Weight excluding battery	0.63 kg

## PXE 80 10.8-EC/2.5 P-Set

### Standard equipment

- 1 adapter, rotary DT-P
- 1 random-orbital adapter, 3 mm stroke DT-XF3
- 1 random-orbital adapter, 12 mm stroke DT-XF12
- 1 adhesive pad 30 Ø BP-M/SR D30 PXE
- 1 hook & loop backing pad 30 Ø BP-M D30 PXE
- 1 hook & loop backing pad 75 Ø BP-M D75 PXE
- 2 polishing sponges PSX-G 40
- 2 polishing sponges PS-V 40
- 2 polishing sponges PS-V 60
- 2 polishing sponges PS-O 60
- 2 polishing sponges PS-R 80
- 1 microfibre cloth MW-PC
- 1 polish P03/06-LDX 250 ml
- 1 polish P05/05-LDX 250 ml
- 2 rechargeable batteries 2.5 Ah AP 10.8/2.5
- 1 charger CA 10.8/18.0
- 1 carrying case L-BOXX® 136
- 1 case insert



Order No.  
469076





## Flexible shaft FS 140

New, clever and quickly ready for use without tools. Working on spots in tricky places has never been so easy. The 140 cm shaft makes using it flexible and ideal in hard-to-reach areas.

### Technical features

- ⊕ Toolless mounting on PXE. The innovative quick-change mechanism of the PXE allows the shaft to be mounted quickly and easily
- ⊕ Toolless quick change of accessories thanks to bit holder. This allows the polishing discs to be changed quickly and easily.
- ⊕ The form fit of the hexagonal mount prevents the polishing bodies from slipping through. This guarantees even and perfect polishing results every time.
- ⊕ The 140 cm shaft can be guided comfortably and conveniently without the polisher tipping or having to be held in the hand all the time.
- ⊕ High-quality materials guarantee an extremely long service life.

### Applications

- ⊕ Paint preparation & scratch removal
- ⊕ Door handle recesses and radiator grille
- ⊕ Exterior mirror casing
- ⊕ Vehicle emblems, logos & lettering
- ⊕ Rims
- ⊕ Spot repair
- ⊕ Interior (piano lacquer, fittings etc.)

### FS 140

#### Standard equipment

- 1 FS 140 in a box

Designation	Order No.
FS 140	506605



### FS 140 Set

#### Standard equipment

- 1 FS 140
- 6 polishing cones (2 each in soft, medium and hard)
- 6 polishing cylinders (2 each in soft, medium and hard)
- 1 deep-drawn insert
- 1 L-Boxx (TK-L 102)

Designation	Order No.
FS 140 Set	516112





**Innovative quick change**  
Toolless mounting on PXE



**Toolless accessory change**

- Bit holder mechanism
- The accessory does not slip in the bit holder
- Form fit for constant work progress
- Rubberised bit holder for maximum surface protection



**Longest service life**  
Highest quality materials for a long service life. Perfect flexibility of the corrugated sheath

**Maximum FLEXibility**  
140 cm length for the ultimate freedom when polishing

**Maximum convenience**

- Perfect ergonomics thanks to extremely slim handle area
- Secure grip while working
- Ideal handle position for guiding when doing the finest work



Green (hard) for deeper scratches



Purple (medium) all-rounder



Orange (soft) for finishing & high sheen



Green (hard) for deeper scratches



Purple (medium) all-rounder



Orange (soft) for finish & high sheen

## Polishing cylinders

- e.g. for mouldings, spot repairs etc.

Product variants	Order No.
Green PZ-G 35 HEX VE5	517755
Purple PZ-V 35 HEX VE5	517763
Orange PZ-O 35 HEX VE5	517771

## Polishing cones

- e.g. for door handle recesses, radiator grille, rims, interior etc.

Product variants	Order No.
Green PK-G 35 HEX VE5	517798
Purple PK-V 35 HEX VE5	517801
Orange PK-O 35 HEX VE5	517828

Cordless random orbital polisher with positive-action drive

# Maximum freedom of movement



# XCE 8 125 18.0-EC

For hologram-free removal of various types of paint damage.  
The ideal complement for anyone who needs a portable random orbital polisher.



## Technical features

- + Electronic Management System (EMS)
- + Brushless motor
- + LED battery capacity indicator
- + 8 mm polishing stroke, positive-action drive provides high abrasive power without creating any holograms
- + Cushioned special hook and loop backing pad
- + Very smooth running thanks to to balancing mass
- + Ideal for tackling the most common surface problems through to finishing without creating any holograms
- + Flat gear head reduces the distance from the surface
- + Handle cover: ergonomically shaped with SoftGrip.
- + Optimised airflow for the best possible cooling effect of the motor and gear-box. No exhaust air to annoy the user
- + Low heat generation on the surface makes it ideal for temperature-sensitive paints

## Cordless eccentric polisher for:

- + Vehicle cleaners
- + Car repair shops
- + Smart repairs
- + Aviation
- + Car dealers
- + Maritime
- + Acrylic glass industry



## Technical data

Max. polishing pad Ø	160 mm
Max. backing pad Ø	150 mm
Stroke	8 mm
No-load speed	280-430/min
Stroke rate at no-load	5600-8600/min
Battery voltage	18 V
Battery capacity	2.5 / 5.0 Ah
Average battery runtime 2.5 Ah	up to 20 min
Average battery runtime 5.0 Ah	up to 45 min
Weight excluding battery	2.1 kg
Weight with 5.0 Ah battery	2.8 kg

## XCE 8 125 18.0-EC C

### Supplied in a box

#### Standard equipment

- 1 special hook and loop backing pad, Ø 125 mm

Order No.

493872

## XCE 8 125 18.0-EC

### Standard equipment

- 1 special hook and loop backing pad, Ø 125 mm
- 1 carrying case L-BOXX® 238
- 1 case insert



Order No.

459070

## XCE 8 125 18.0-EC/5.0 Set

### Standard equipment

- 1 special hook and loop backing pad, Ø 125 mm
- 2 rechargeable batteries 5.0 Ah AP 18.0/5.0
- 1 charger CA 10.8/18.0
- 1 carrying case L-BOXX® 238
- 1 case insert



Order No.

438413

## XCE 8 125 18.0-EC/5.0 P-Set

### Standard equipment

- 1 polishing sponge PS-0 140
- 1 polishing sponge PSX-G 140
- 1 polish P03/06-LDX 250 ml
- 1 polish P05/05-LDX 250 ml
- 1 microfibre cloth MW-PC
- 1 special hook and loop backing pad, Ø 125 mm
- 2 rechargeable batteries 5.0 Ah AP 18.0/5.0
- 1 charger CA 10.8/18.0
- 1 carrying case L-BOXX® 238
- 1 case insert



Order No.

461245

# System with in-built safety

Polish and pad play a crucial role in the polishing process. FLEX therefore provides a perfectly coordinated system with an optimum range of sponges for every application: simply use the correct colour to successfully achieve your goal.



## Abrasive paste P 05/05-LDX

High removal rate  
with maximum sheen

The universal high-performance abrasive paste removes P1500 grit abrasion marks in seconds.

- Suitable for all types of paint
- Contains no wax, silicone, or odorous solvents
- For use with rotary and random orbital polishers
- Abrasiveness 5
- Gloss level 5

Order No.  
443271



## Special polish P 03/06-LDX

Scratch removal  
with a deep sheen

Ideal for polishing P2000 grit abrasion marks and for reviving old paintwork.

- Suitable for all types of paint
- Low-dust and silicone-free polish
- For single-stage random orbital polishing or rotary polishing
- Abrasiveness 3
- Gloss level 6

Order No.  
443298



## Sealant W 02/04

Liquid preservation

Perfect paintwork protection with Carnuba wax

- For new or freshly polished paintwork
- Can be painted over
- Contains no abrasive particles
- Protects, cares for and maintains high sheen
- Can be applied with the red manual applicator sponge or with the orange sponge and a polisher.
- Protective effect 2
- Smoothness 4

Order No.  
443301

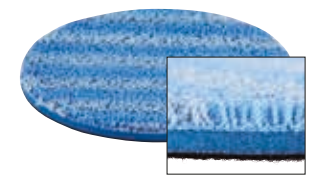
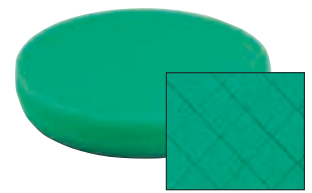

For more accessories, visit [www.flex-tools.com](http://www.flex-tools.com)

## Sponge types

### Cutting Power

### Designation Ø Order No. sizes

#### Green sponge - PSX-G

A very hard, reticulated foam with an innovative X-Cut surface that guarantees a uniform and very high removal rate even when used with the random orbital polisher. The X-Cut texture also reduces heat generation. The foam is heat resistant, tear resistant, and has a very good service life.



PSX-G 40 VE2	442631
PSX-G 60 VE2	492434
PSX-G 80 VE2	434264
PSX-G 140	434272
PSX-G 160	434280
PSX-G 200	434299

#### Violet sponge - PS-V

A hard, reticulated foam for optimum cooling and with a constant and high removal rate. It is slightly less abrasive than the green sponge PSX-G and is ideal for fresh coats of paint. The foam is heat resistant, tear resistant and has a good service life.



PS-V 40 VE2	442658
PS-V 60 VE2	492442
PS-V 80 VE2	434442
PS-V 140	434450
PS-V 160	434469
PS-V 200	436410

#### Orange sponge - PS-O

A medium-hard, reticulated foam with a fine foam texture. It is heat resistant, very tear resistant and has a good service life.



PS-O 40 VE2	442666
PS-O 60 VE2	492450
PS-O 80 VE2	434302
PS-O 140	434310
PS-O 160	434329
PS-O 200	434337

#### Red sponge - PS-R

A very soft, reticulated foam with a fine foam texture. It has a special PerfectTouch sandwich structure with an additional, firmer, white foam layer which gives the pad greater rigidity. This special structure also increases the service life of the polishing pad.



PS-R 40 VE2	442674
PS-R 80 VE2	434345
PS-R 140	434353
PS-R 160	434361
PS-R 200	434426

#### Blue sponge - Microfibre polishing pad MC-PT 160

Especially for random orbital polishers, particularly those with a free-running pad. With these machines, a microfibre pad is more effective than a standard fleece pad for heavy cutting work. The microfibre pad is also equipped with the tried-and-tested PerfectTouch sandwich surface. This ensures good pressure distribution without softening the orbital movement.



MC-PT 160	434434
-----------	--------

#### White pad - Wool polishing pad TW-PT

TopWool Pad made from 90% natural wool and 10% polyester. This combination gives it a longer service life and more volume. The special PerfectTouch structure with the additional layer of orange foam gives the pad gentle cushioning and greater rigidity.



TW-PT 80	420484
TW-PT 140	376515
TW-PT 160	376523

#### Small red sponge - manual application sponge PUK-R 130

This sponge has an ergonomic shape and a very soft, reticulated foam with a fine foam texture. It is perfect for the manual application of sealants and care products to painted and plastic surfaces. An ideal supplement for difficult to reach places or sensitive surfaces that are difficult to treat with a tool, for example.



PUK-R 130	442682
-----------	--------

# The right choice

FLEX gives you an overview. So that application, tool and accessories produce the perfect result.



**Rotary**

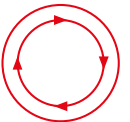

**Random orbital, with positive-action drive**



**Random orbital, free-running**



**Rotary**

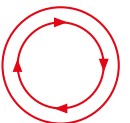

**Random orbital, with positive-action drive**



**Random orbital, free-running**



For more accessories, visit [www.flex-tools.com](http://www.flex-tools.com)

# Damage

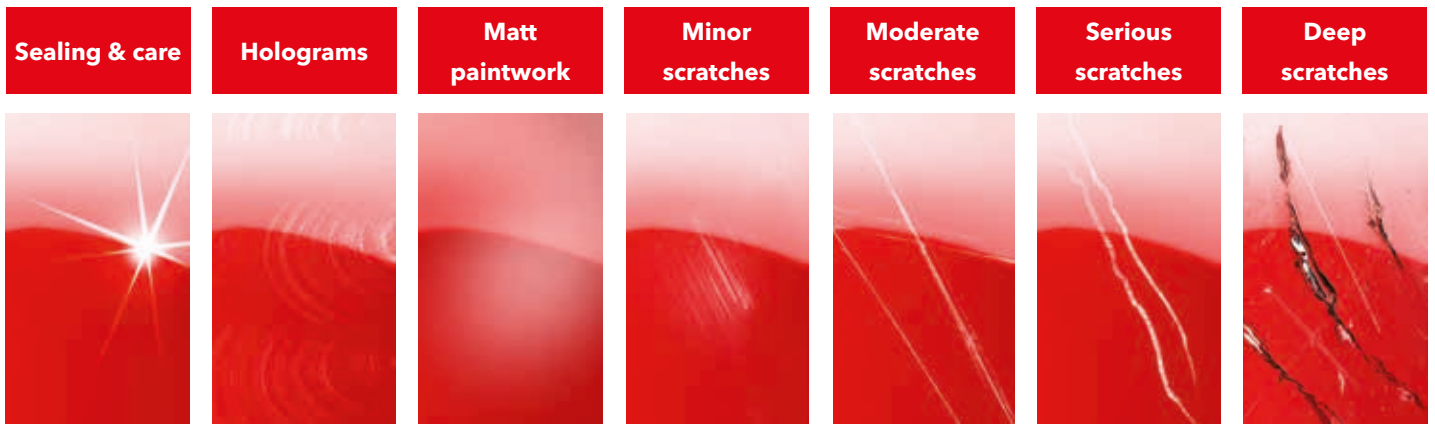

## Fields of application of the drive types



## Fields of application of the pads and polishes

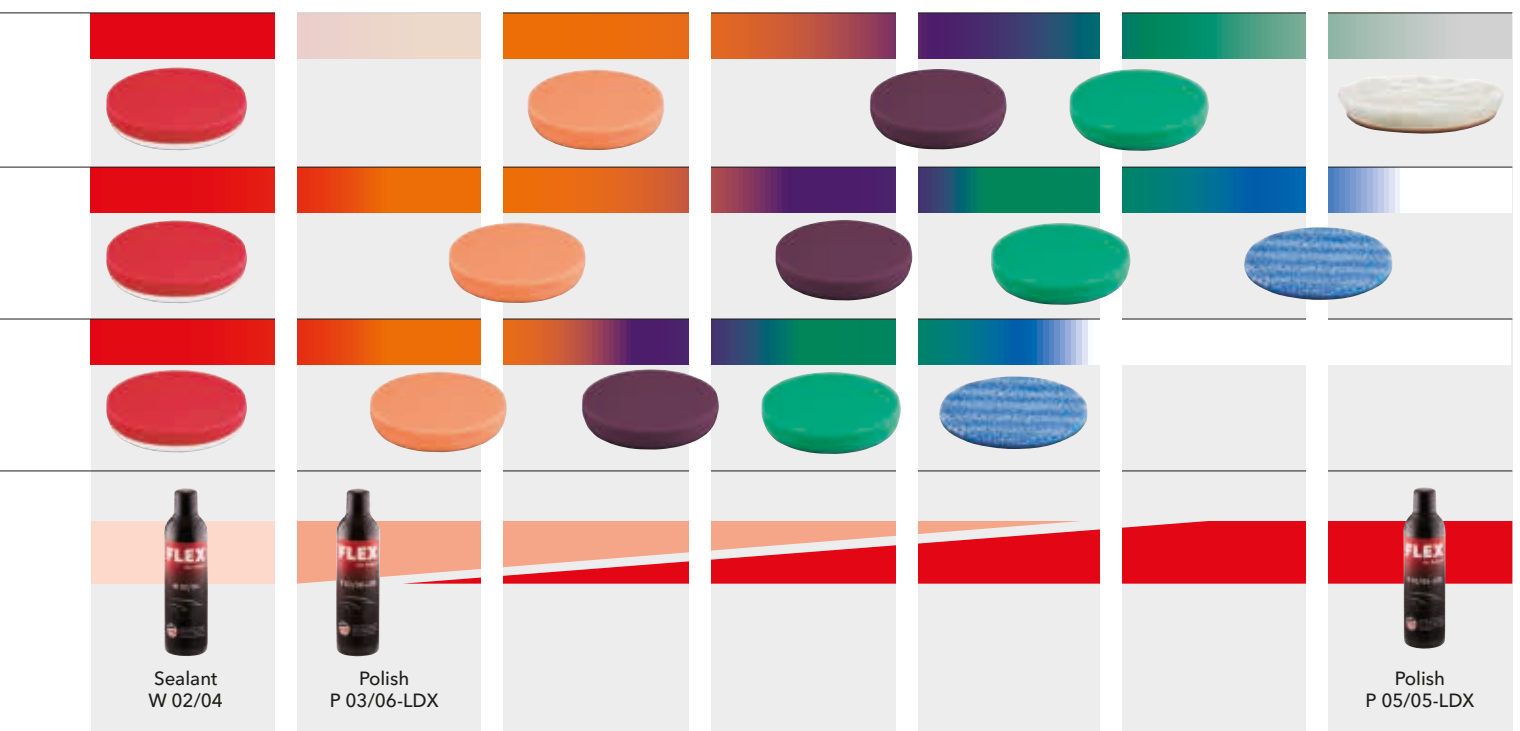

Automotive products

# Everything for the workshop





## DWL 2500 10.8/18.0

Powerful LED full-spectrum light with max. 3000 lumen and extremely long runtime of up to 30 hours (300 lm).

### Technical features

- + With Bluetooth app for lighting control for up to 4 lights and brightness setting in 5 stages
- + The all-daylight function allows the colour temperature to be set in 5 stages between 2500 K - 6500 K. This enables an accurate adjustment to the job in hand
- + Ideal for checking the paint surface, determining colour and detecting paintwork mistakes, holograms, scratches
- + Integrated powerbank, USB port and charging option for smartphones, tablets
- + Robust and durable for the most exacting demands
- + Connecting thread for tripods
- + LED battery capacity capacity indicator



### DWL 2500 10.8/18.0

Order No.  
486728



Using the FLEX Light-Control app allows you to control the DWL with ease from your smartphone.

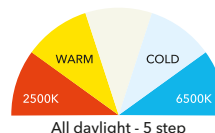

### Accessories

- Magnetic holder WB-M/DWL



Order No.  
491195

## SF 150-P Swirl Finder

Ideal LED light to control surface conditions.

Due to the colour temperature and reproduction, surface damage such as holograms, scratches etc. can be made more visible. Light intensity 140 lumens and adjustable focus with a beam angle of 10° - 70°, lighting time approx. 2 hours incl. batteries.



Order No.  
463302

## CI 11 18.0 / 12V

Cordless compressor 12.0 / 18.0 V

### Technical features

- + Pressure presetting with automatic switch-off when the desired pressure is reached
- + Perfect flexibility thanks to 18 V battery power and 12 V on-board voltage via cigarette adapter. For filling car and bicycle tyres



Order No.  
506648

## BW 18.0-EC

Cordless fan / leaf blower 18.0 V

### Technical features

- + 18 V battery power, perfect for drying painted surfaces
- + Ideal for hard-to-reach places thanks to compact design



Battery pack not included

Order No.  
472913

## VC 6 L MC

Compact vacuum cleaner with manual filter cleaning, 6 l, class L

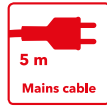

### Technical features

- ⊕ Small, compact, mega power - the small vacuum cleaner with cable
- ⊕ Very compact, handy and light vacuum cleaner with carrying strap for portable use. The compact design means it fits in all vehicles



Order No.  
481513

## VC 6 L MC 18.0

Compact vacuum cleaner with manual filter cleaning, 6 l, class L



### Technical features

- ⊕ Small, compact, mobile - with powerful 18 V battery power
- ⊕ Perfect for professional cleaning of vehicles, workshops, warehouses, final assembly, offices, etc.



Battery pack not included

Order No.  
481491

## ORE 3-150 EC / ORE 5-150 EC

Powerful random orbital sander with speed control, 150 mm

### Technical features

- ⊕ Sanding speed suitable for the material thanks to adjustable speed
- ⊕ Impact-resistant filter cartridge with replaceable PES filter allows easy dust disposal or cleaning of the filter with maximum service life
- ⊕ Tools also available in L-BOXX®

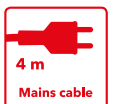

## ORE 3-150 EC

Order No.  
447684

## ORE 5-150 EC

Order No.  
447706

## RD 10.8/18.0/230

Digital cordless construction site radio 10.8 / 18.0 V

### Technical features

- ⊕ Cordless construction site radio with mega sound and LED light strips
- ⊕ With integrated Bluetooth® technology, AUX input, USB port and charging option for smartphones, tablets

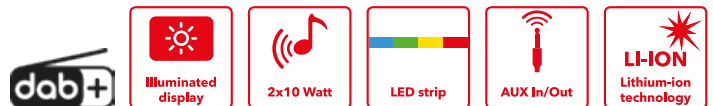

Order No.  
484857

## DD 2G 10.8-EC

2-speed cordless drill driver 10.8 V

### Technical features

- ⊕ The powerful all-rounder
- ⊕ With quick-change system, this enables simple, toolless changing of the angle attachment, drill chuck and bit holder
- ⊕ The tool is also available as a set in a L-BOXX® with a charger and two 4.0 Ah battery packs

Order No.

418005



Battery pack not included

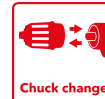

## IW 3/4" 18.0-EC C

Cordless impact screwdriver 18.0 V

### Technical features

- ⊕ Square drive for 3/4" drive sockets
- ⊕ Powerful impact mechanism: Highest power enables stuck e.g. rusted screw connections to be loosened even in extreme applications
- ⊕ The tool is also available as a set in a L-BOXX® with a quick charger and two 5.0 Ah battery packs

Order No.

492612



Battery pack not included



## IW 1/2" 18.0-EC C

Cordless impact screwdriver 18.0 V

### Technical features

- ⊕ Speed command: Three different speed ranges can be set for different applications. One of the benefits is that this prevents small screws from being overtightened
- ⊕ Integrated LED lamp with afterglow function
- ⊕ The tool is also available as a set in a L-BOXX® with a quick charger and two 5.0 Ah battery packs

Order No.

491268



Battery pack not included



# Long performance guaranteed

This is Proformance. This is FLEX.

3

YEARS

FLEX WARRANTY

## 3-year warranty

Simply register and use the 3-year warranty immediately at [warranty.flex-tools.com](https://warranty.flex-tools.com)



Our products are thoroughly tested to ensure FLEX premium quality. That's why with the 3-year guarantee, we offer you a free, all-round carefree package - on all power tools\*, Li-ion batteries, the associated chargers and laser measuring devices.

To benefit from the warranty, simply register your device within 30 days of purchase:

- 🔧 Warranty period extended to three years
- 🔧 Service certificate in case a repair is required
- 🔧 Tracking of repair status if the machine is under warranty

\*Does not apply to H Class vacuum cleaners.



Would you like to have your warranty certificates always on your smartphone and manage them while on the go? No problem - use the 3-year warranty service easily while on the move with the FLEX Warranty app.

Simply download the free app to use the service:



For more information about our automotive range, please contact your competent specialist dealer



or



FLEX-Elektrowerkzeuge GmbH

Bahnhofstrasse 15 71711 Steinheim Germany

[www.flex-tools.com](https://www.flex-tools.com)

The configuration of the machines is the same as the usual basic equipment. Subject to VAT changes, technical changes, price changes and errors. All prices in bold are recommended prices plus VAT.

**FLEX**

EN / 04-2022