

LD 16-8 125 R
LDE 16-8 125 R

ETL-Nr. 511.137 Blatt 1
Stand 03-2023

Schutzhaube Ø 125

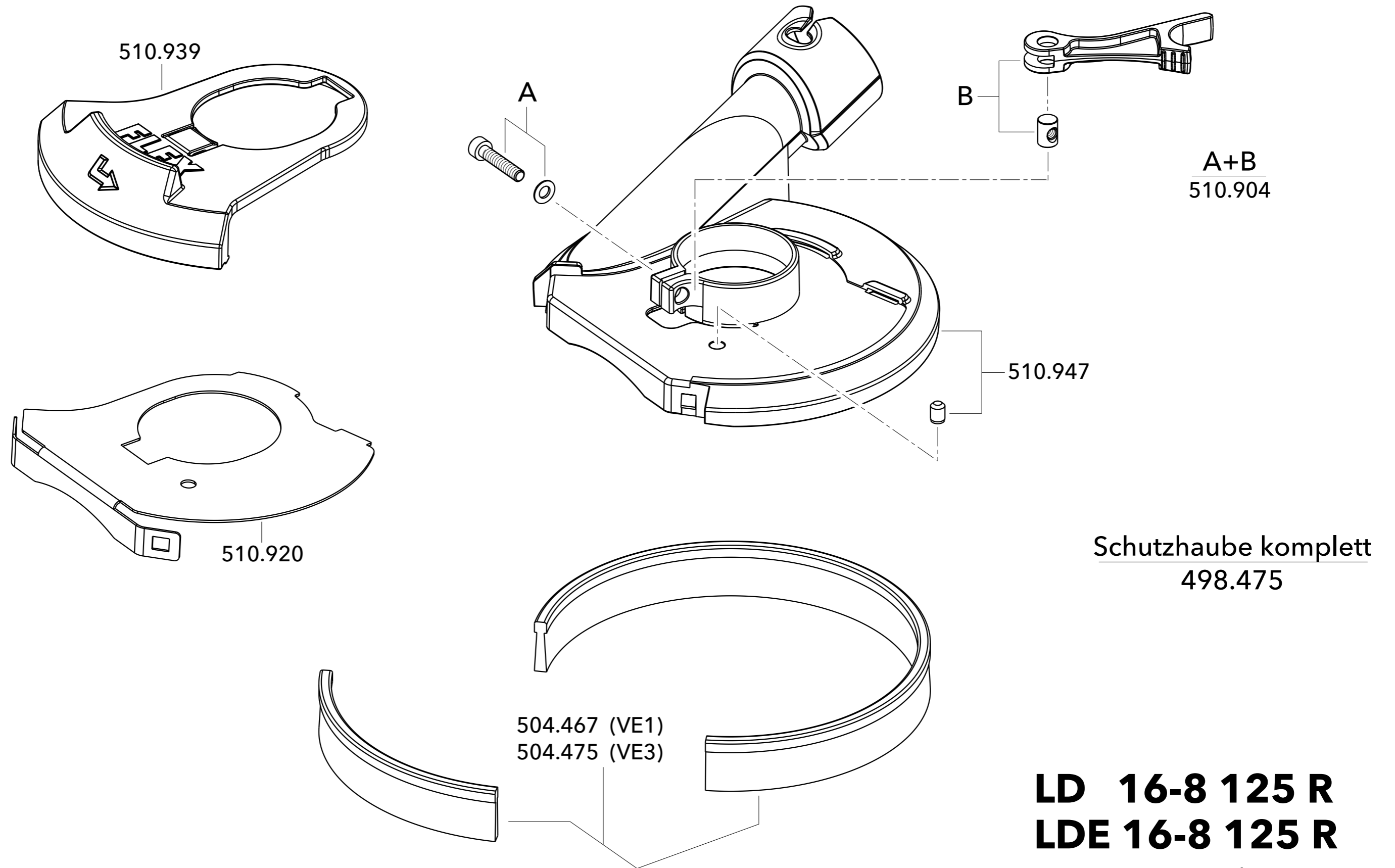

Schutzhaube komplett
498.475

LD 16-8 125 R
LDE 16-8 125 R

ETL-Nr. 511.137 Blatt 2
Stand 04-2021